

fama



Famatab
Sole&Luna
Nordik
Nexus
Aston-Marcel-Luke
LuciPop
Conec-Table
AdapTable
Triovo
Klee&Klever

+ IMAGINE

Seguridad: Mesas sin aristas vivas
Safety: No sharp edges
Sécurité: Des tables sans aucun coin pointu
Sicherheit: Tische ohne spitze Kante



Comodidad: Tapa elevable
Comfort: Lifting top
Commodité: Plateau relevable
Komfort: Hebedeckel



Roble Natural Cerezo



Negro Humo



Perla Piedra



Mar Pistacho



Nogal Wengue



Nube Plata



Blanco Champagne



Fucsia Naranja

Combinación: A juego de tus sofás
Style: matching your sofa
Combinaison: Harmonie avec vos canapés
Zusammenstellung: an Ihrer Sofas gepasste Tische



Funcionalidad: Desplazar sin esfuerzo
Functionality: Easy to move
Fonctionnalité: Déplacer sans effort
Funktionalität: mühelos beweglich



Utilidad extra: Arcón incluido
Extra use: Storage
Utilité extra: Caisson inclus
Extra Brauchbarkeit: Inklusive Truhe



Diferentes: Formas adaptables, colores diferentes
Different: Adaptable shapes, different colours
Différents: Formes adaptables, les différentes couleurs
Besondere: angepasste Formen, verschiedene Farben



Los colores reflejados son sobre impresión. Para ver el color real consultar el muestrario original.

The colours shown may vary due to the printing. To see the exact colours please check the wood samples.

Les couleurs reflétées sont sur impression. Pour voir la couleur réelle, consulter l'échantillonnage original.

Die Farben können wegen des Druckes wechseln. Um die wirklichen Farben zu sehen, sollen Sie im originalen Musterbuch nachschlagen.

Acabados disponibles para las tapas de todas nuestras mesas

Finishes available for the tops of all our tables

Finitions disponibles pour les plateaux de toutes nos tables

Verfügbare Holzplatte Finishes von allen unseren Tischen

Design:
 Félix López Gil
 2012

fama





Adam 110



Adam 96



Adam 70



Elsa



Flavio



Lucas



Carol



Otis

Famatab es nuestra línea de mesas tapizadas con tapa elevable y arcón que podrás combinar con tu sofá o sillón.

Famatab is our range of upholstered tables with lifting top and storage box that can be customised to match your sofa or armchair.

Famatab est notre ligne de tables tapissées avec plateau relevable et caisson que vous pourrez combiner avec votre canapé ou votre fauteuil.

Famatab ist unser Sortiment an gepolsterten Tischen mit Hebeplatte und Aufbewahrungsbox, die an Ihr Sofa oder Sessel angepasst werden können.



Carol



Adam 96



Adam 96

Ariane Love
Sole & Luna

26



Sole

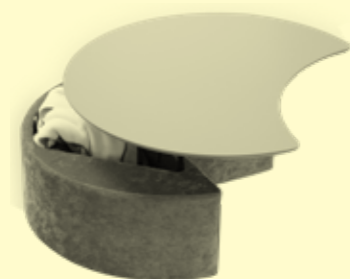

Luna

Dentro de la familia de mesas Famatab contamos con las mesas Sole & Luna (ideales para nuestro sofá estrella Ariane). Son mesas tapizadas con tapa elevable y arcón, que podemos personalizar y combinar con nuestro sofá o sillón.

Belonging to the Famatab family, Sole & Luna are the tables from our modular group Ariane Love. They are upholstered tables with lifting top and storage box that we can customise to match our sofa or armchair.

Dans la famille des tables Famatab, il y a les tables Sole & Luna (idéales pour notre canapé Ariane Love). Ce sont des tables tapissées avec un plateau relevable et caisson, que nous pouvons personnaliser et combiner avec notre canapé ou fauteuil.

Zu der Famatab-Familie gehören Sole & Luna die Tische von unserer modularen Gruppe Ariane Love. Sie sind gepolsterte Tische mit Hebeplatte und Aufbewahrungsbox, die wir an unsere Sofa oder Sessel anpassen können.



Luna

Venetian



Sole



Luna

NORDIK



Adam 70 Nordik



Adam 96 Nordik



Adam 110 Nordik



Elsa Nordik



Otis Nordik



Lucas Nordik

Mesas de gran ligereza visual. Sencillas, atractivas y funcionales. Disponibles en la mayoría de tamaños y formas de las mesas Famatab, y con una gran variedad de colores.

Tables of great visual lightness. Simple, attractive and functional. They are available in most sizes and shapes of Famatab tables, and in a great variety of colours.

Ce sont des tables de grande légèreté visuelle. Simples, attractives et fonctionnelles. Disponibles dans plusieurs dimensions et formes des tables Famatab, et avec une grande variété de couleurs.

Tische von großer visueller Leichtigkeit. Einfach, attraktiv und funktionell. Sie sind in den meisten Größen und Formen von Famatab Tischen und in einer großen Vielzahl von Farben verfügbar.

26



Elsa Nordik



Lucas Nordik



Lucas Nordik

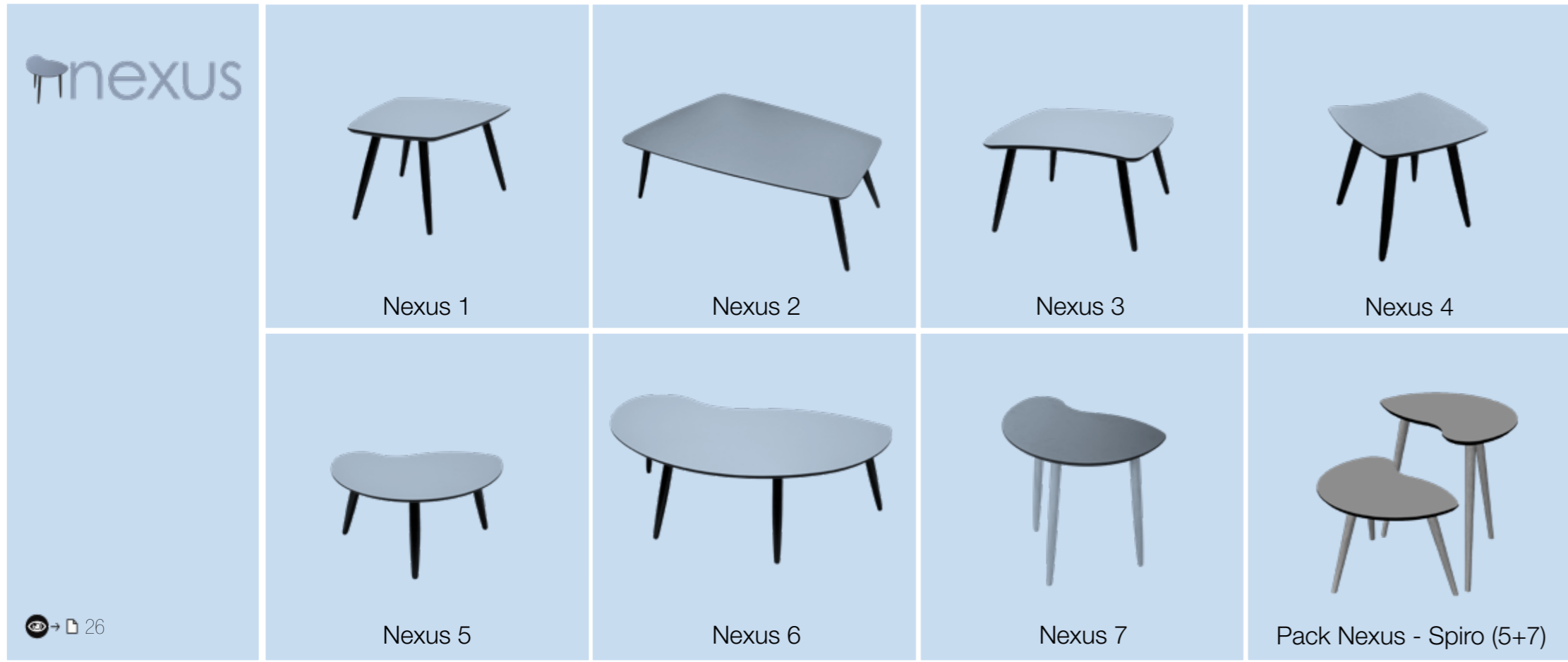

26



Pack Nexus - Spiro (5+7)



Nexus 2

Las mesas Nexus son el complemento perfecto para tu hogar gracias a su ligereza y a la gran cantidad de diseños disponibles. Las mesas Nexus están disponibles con tablero de fibra en acabado Portland, y ahora también en todos los colores de tapas de Famatab.

Nexus tables are the perfect accessory for your home thanks to their lightness and to the great variety of designs available. Nexus tables are available with a Portland fibre finish, and now also with a lacquered finish in all the colours of the Famatab tops.

Les tables Nexus sont le complément parfait pour votre maison en raison de leur légèreté et de la grande quantité de modèles disponibles. Les Tables Nexus sont disponibles avec une finition Portland de fibre, et maintenant disponibles également avec une finition laquée dans toutes les couleurs des plateaux Famatab.

Nexus Tische sind das perfekte Accessoire für Ihr Zuhause dank ihrer Leichtigkeit und der vielen Designs. Nexus Tische haben eine Portlandfaser-Oberfläche und auch ein lackierte Verarbeitung in allen Farben von Famatab Platten.



Nexus 6

MARCEL

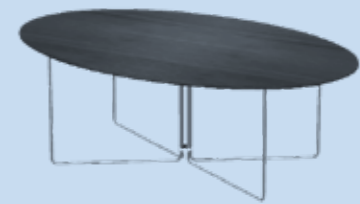

Otis



Elsa

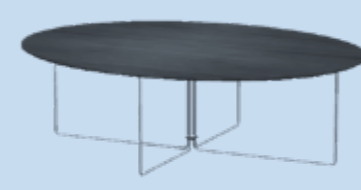

Flavio

Aston



Otis



Elsa

LUKE



Luke



Luke - R

26



Luke



Aston - Otis

Aston, Marcel y Luke son mesas de complemento ligeras y elegantes. Aston con patas de madera torneadas, y Marcel y Luke con unas finas varillas de aluminio. Están disponibles en distintas formas y medidas.

Aston, Marcel and Luke are occasional tables, very light and elegant. Aston with wooden toned legs, and Marcel and Luke with thin aluminium rods. They are available in different shapes and sizes.

Aston, Marcel et Luke sont des tables légères et élégantes de complément. Aston avec pieds en bois tournés, et Marcel et Luke avec des tiges fines en aluminium. Elles sont disponibles dans plusieurs dimensions et formes.

Aston, Marcel und Luke sind sehr leichte und elegante Beistelltische. Aston mit Holzbeinen und Marcel und Luke mit dünnen Aluminiumstäben. In verschiedenen Formen und Größe verfügbar.

Marcel - Otis

Conec-Table



Spiro 38 - Basic



Spiro 60 - Basic



Spiro 60 + E



Spiro PACK 1 - Basic



Spiro PACK 2 - Basic + E

Conec-Table, una serie de mesas de complemento que nos facilitan uno de los gestos que más a menudo realizamos en nuestras casas: cargar nuestro móvil o Tablet.
Fusionamos una mesa de complemento con una lámpara integrada, y además, con un sencillo sistema de carga para los móviles a través de puerto USB.

Daher ist Conec-Table geboren werden, es ist eine Linie von Beistelltische, die uns eine unserer neuen Bedürfnisse ermöglicht: das Handy oder Tablet zu laden.
Wir verbinden den Beistelltisch mit einer integrierten Lampe. Außerdem hat es ein einfaches System für das Laden der Handys durch einen USB-Anschluss sein.

Conec-Table, a range of auxiliary tables that make one of the most often performed gesture in our homes a lot easier: charging our mobile phone or Tablet.
We have combined an auxiliary table with a built-in lamp, and also, with a simple system to charge our mobile phones through a USB port.

Conec-Table, une série de tables de complément qui nous facilitent l'un des gestes le plus souvent utilisé dans nos maisons: charger le portable ou la tablette.
Nous fusionnons une table de complément avec une lampe intégrée, et en plus, avec un simple système de charge pour les portables à travers d'un port USB.

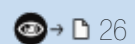

Spiro PACK 1 - Basic



Spiro 38 - Basic



Spiro 60 + E

AdapTable



Pop - Flavio



Pop - Enya

Nueva línea de mesas con una importante funcionalidad: mesas de centro que en un abrir y cerrar de ojos se pueden convertir en mesas de comedor.

POP Inspirándonos en las míticas mesas de camping plegables, hemos creado Pop, un ejemplo de sencillez, perfección y ligereza. El ingenioso juego de líneas y ángulos formado por sus patas da lugar a un original diseño que permite elevar la mesa de una forma ágil y sencilla.

New range of tables with a great functionality: they can be turned from accessory tables into dining tables in the blink of an eye.

POP Inspired by the popular camping folding tables, we have designed Pop, an example of simplicity, perfection and lightness. The clever combination of lines and angles formed by its legs creates an original design that allows raising the table in a quick and simple way.

Nouvelle ligne de tables avec une fonctionnalité importante: tables basses qui peuvent se convertir en un clin d'oeil en tables de salle à manger.

POP Nous nous inspirons des tables mythiques de camping qui se replient, nous avons créé Pop, un exemple de simplicité, de perfection et de légèreté. Le jeu ingénieux de lignes et d'angles formé par ses pieds, donnent lieu à une conception originale qui permet d'élever la table d'une forme agile et simple.

Neue Linie von Tischen mit eine wichtige Funktionalität: Couchtische, die im Nu in Esstische werden können.

POP Von den beliebten Camping-Klapptische inspiriert. Wir haben Pop designt, ein Beispiel für die Einfachheit, Perfektion und Leichtigkeit. Die geschickte Kombination aus Linien und durch seine Beine schaffen ein originelles Design, das der Tisch in eine schnelle und einfache Art und Weise zu erhöhen ermöglicht.



Pop - Flavio



fama



Pop - Enya

LUCIPOP



Luci Pop R1 / R2



Luci Pop OCTO



Luci Pop S



Luci Pop CIRCLE

Dentro del modelo LuciPop hemos creado una colección de mesas de complemento con distintas formas y alturas, que se pueden adaptar a la mayoría de nuestros modelos de sofás. Las patas de varilla metálica las hacen muy ligeras visualmente, y las originales formas de las tapas las convierten en el complemento perfecto para usar en los sofás o para decorar cualquier rincón. Están disponibles en dos alturas, 48cm y 56cm.

Within the LuciPop model we have created a collection of accessory tables with different shapes and heights that can be adapted to most of our sofas. The metal rod legs make them visually light, and the original top shapes turn them into the perfect complement to use on sofas or to decorate any space. They are available in two heights, 48cm and 56cm.

Dans le modèle LuciPop, nous avons créé une collection de tables d'appoint avec différentes formes et hauteurs, qui peuvent être adaptées à la plupart de nos modèles de canapés. Les pieds en métal le rendent très légers visuellement, et les formes originales des plateaux en font le complément parfait pour utiliser sur les canapés ou pour décorer n'importe quel endroit. Ils sont disponibles en deux hauteurs, 48cm et 56cm.

Unter dem Modell LuciPop haben wir eine Linie von Ergänzungstischen design, mit verschiedenen Formen und Höhen, die sich an den Meisten unserer Sofas Modelle anpassen lässt. Die Metall Bügelbeine lassen ein viel leichteres visuelles Design erscheinen, zusammen mit den originalen Platten Formen, ergeben das perfekte Ergänzungsmöbelstück für jedes Sofa oder auch als Eckmöbel, um jede Ecke zu dekorieren. Die Tische sind in zwei Höhen verfügbar, 48 cm und 56 cm.



Luci Pop CIRCLE / Luci Pop OCTO



Luci Pop S



Luci Pop OCTO

Luci Pop R2

TRIOVO

Tableros / Boards / Plateau / Platte

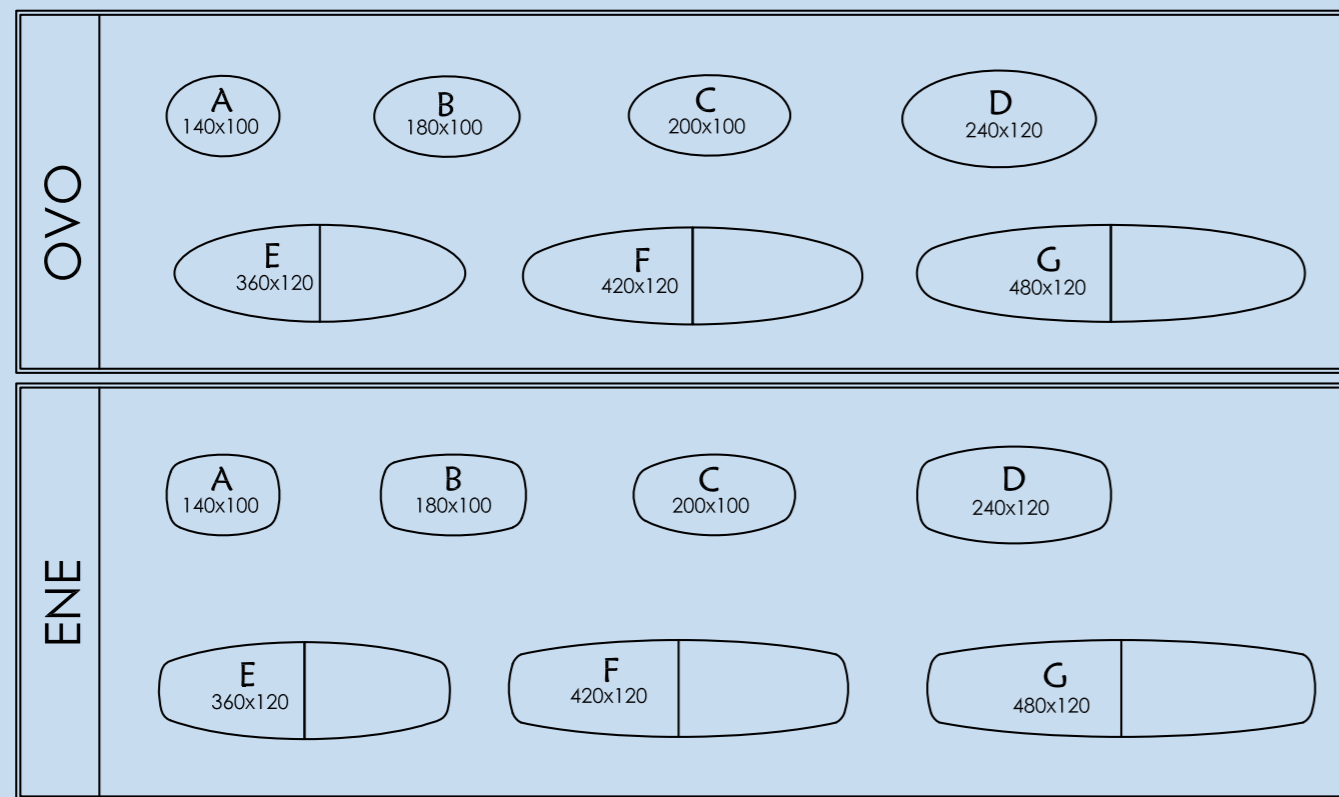

Caballete / Support
Trépied / Stative

27

TRIOVO es un sistema de mesas formadas por tableros de distintas formas y medidas, y tripodes/ caballetes independientes que se adaptan a todas las necesidades que se puedan presentar tanto en el hogar (comedores, cocinas, office, celebraciones familiares, etc), como en instalaciones (hostelería, restauración, centros de negocios y congresos, por ejemplo). Los tableros se colocan sobre tripodes independientes de forma rápida y sencilla mediante un sistema patentado que ofrece una estabilidad inmejorable y no molesta a los usuarios que se sientan junto a las patas. Además es ligero y fácil de montar y desmontar. Existen distintas alturas de caballetes, para adaptarse a cualquier necesidad.

TRIOVO is a new system of tables formed by boards and separate leg supports that can be adapted to all the needs that may arise both in the home (dining rooms, kitchens, office, family celebrations, etc), or in contract (restaurants, hotels, business or congress centres, etc). The boards are easily placed on independent supports using a patented system that offers a perfect stability. What's more, these legs do not inconvenience the person that sits in front of them. Moreover, it is light and easy to assemble and disassemble. The leg supports are available in different heights to adapt to any space or need.

TRIOVO est un système de tables formées par des plateaux et des trépieds indépendants qui permettent de s'adapter à toutes les besoins qui peuvent se présenter dans une maison (salle à manger, cuisines, bureaux, fêtes de famille, hôtellerie, restauration, centres d'affaires et congrès, etc). Les plateaux sont positionnés sur les trépieds indépendants de manière simple et rapide grâce à un système breveté qui offre une stabilité optimale et qui ne les gêne pas les personnes qui s'assoient à côté des pieds. De plus, ils sont légers et facile à monter ou démonter. Il existe différentes hauteurs de chevalets, pour s'adapter à n'importe quel besoin.

TRIOVO ist ein Tisch System bestehend aus verschieden förmigen und großen Platten, sowie unabhängige Gestelle, die sich an alle Bedürfnisse im Haus (Esszimmer, Küche, Studio, Familienfeier, etc.) oder in großen Einrichtungen (z. B. Hotels, Restaurants, Geschäftszentren und Kongressen) anpassen. Die Platten werden auf einer schnellen und einfachen Weise mit einem patentierten System über die unabhängigen Gestelle platziert. Dieses System bietet eine einwandfreie Stabilität an, auf dieser Weise stören die Beine des Tisches dem Benutzer nicht. Außerdem ist es leicht und einfach ab und anzubauen. Die Gestelle sind in verschiedenen Größen zur Verfügung, um sich am besten an die Bedürfnisse anzupassen.



Klee&Klever

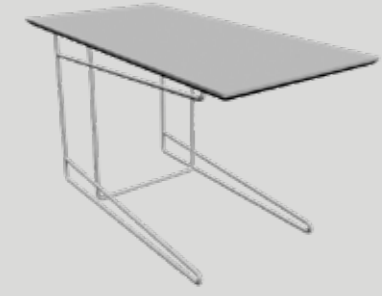

Klee "K" (96x48)

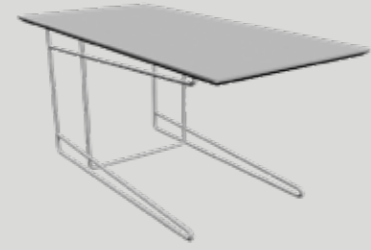

Klee "J" (96x48)

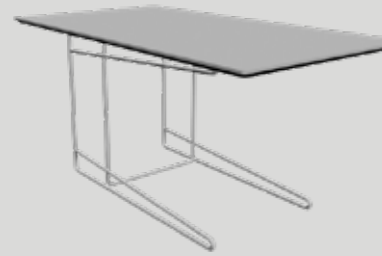

Klee "H" (110x60)

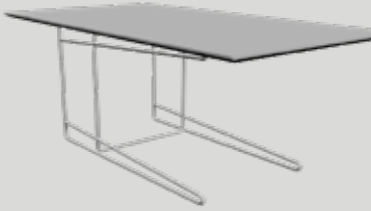

Klee "G" (110x60)



Dentro de la familia Klee&Klever hemos creado una nueva línea de mesas muy ligeras visualmente y con una gran versatilidad, ya que se pueden usar como mesa de centro, pero también se pueden acoplar al sofá para cenar, leer, escribir, etc. Gracias al diseño de su base de varilla metálica se pueden usar en la mayoría de nuestros modelos de sofá y modular. Existen dos tamaños de tapa, y están disponibles en dos alturas. También pueden llevar nuestros acabados de impresión digital, Imagine.

Au sein de la famille Klee&Klever, nous avons créé une nouvelle gamme de tables très légères visuellement et avec une grande polyvalence, car elles peuvent être utilisées comme table basse, mais peuvent également être couplées au canapé pour dîner, lire, écrire, etc. Grâce à la conception de sa base de tige métallique, vous pouvez l'utiliser dans la plupart de nos modèles de canapé et modulaire. Il y a deux tailles de plateaux et ils sont disponibles en deux hauteurs. Ils peuvent aussi se faire avec nos impressions numériques Imagine.

Within the Klee&Klever family we have created a new line of accessory tables, very light visually and with great versatility, since they can be used as a coffee table, but they can also be placed in the middle of the for dinner, reading, writing, etc. Thanks to the design of their metal rod base, they are suitable for most of our models of sofa and modular groups. There are two top sizes, and two different leg heights. They are also available with our Imagine finish (digital printing).

Unter der Familie von Klee&Klever haben wir eine Linie von visuellen schlichten und vielseitigen Tischen design. Diese Tische können sowohl als Kaffeetisch benutzt werden, als auch an das Sofa verbunden werden, um zu essen, lesen, schreiben, etc. Dank dem Design der Metallbeine passt es fast zu jeden unserer Sofa-Modelle. Die Platte ist in zwei Größen verfügbar und es gibt zwei verschiedenen Höhen. Die Platten können auch mit unserer Digitaldruckanfertigung, Imagine, lackiert werden.



Klee "G" (110x60)



Klee "G" (110x60)

Imagine



Imagine es un nuevo sistema de Impresión Digital que nos permite ofrecer acabados distintos en prácticamente todas las mesas de nuestro catálogo.

Imagine is a new Digital Printing system that allows us to offer different finishes in almost all our tables.

Imagine est un nouveau système d'impression digital qui nous permet d'offrir des différentes finitions sur la plupart de tables de notre catalogue.

Imagine ist ein neues Digitaldrucksystem, mit dem wir aller Art von Anfertigung unserer unterschiedliche Ausführungen anbieten können.

Klee

Famatab

pag. 4-5

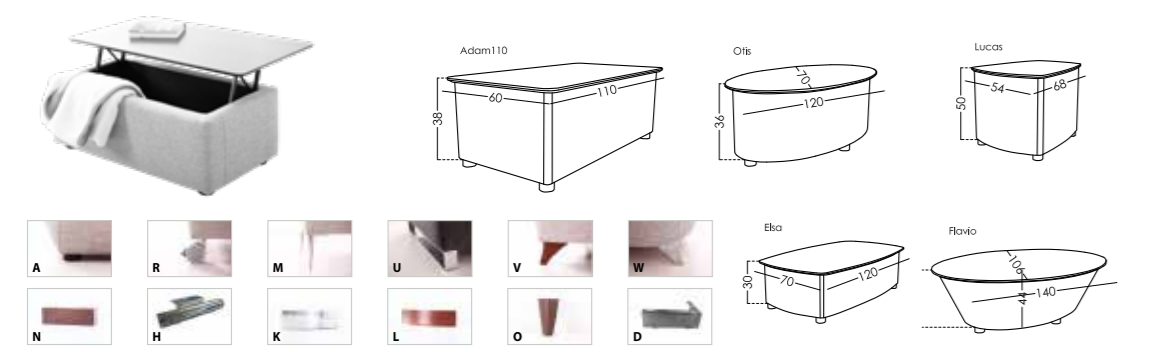

Nexus

pag. 10-11

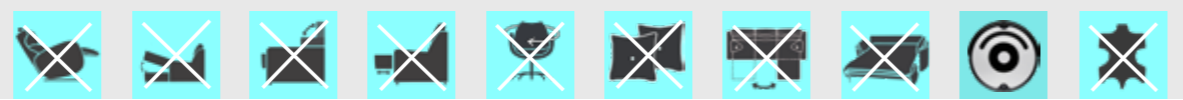
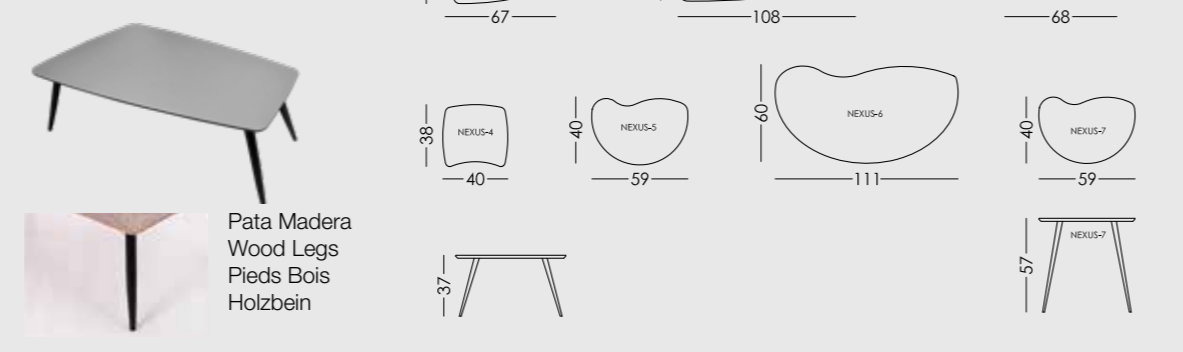

AdapTable

pag. 16-17



Klee&Klever

pag. 22-23

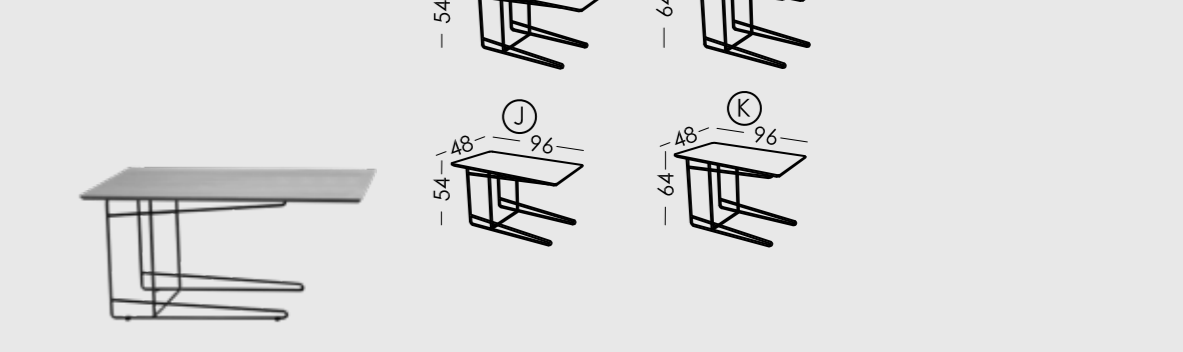

Sole&Luna

pag. 6-7

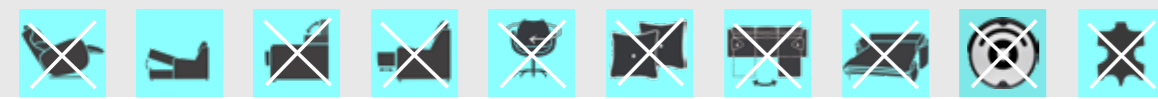
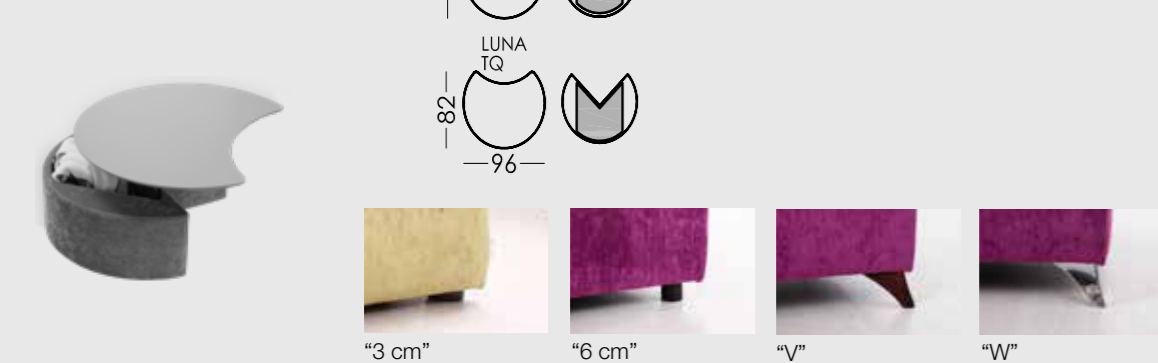

Aston-Marcel-Luke

pag. 12-13

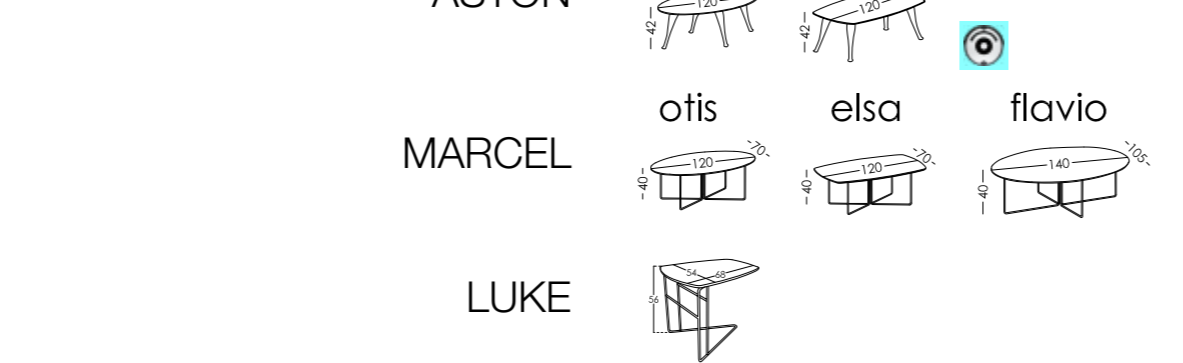

LuciPop

pag. 18-19

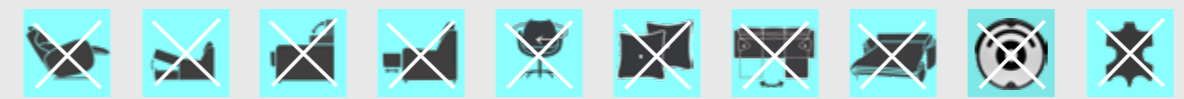
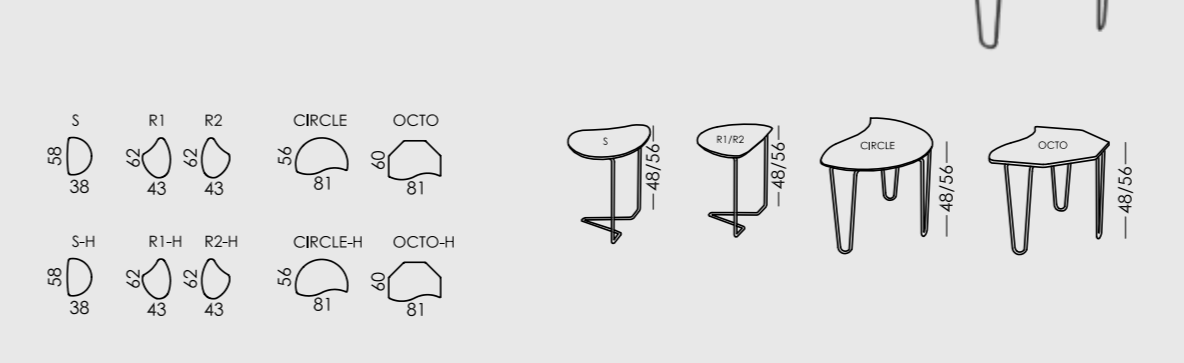

Nordik

pag. 8-9

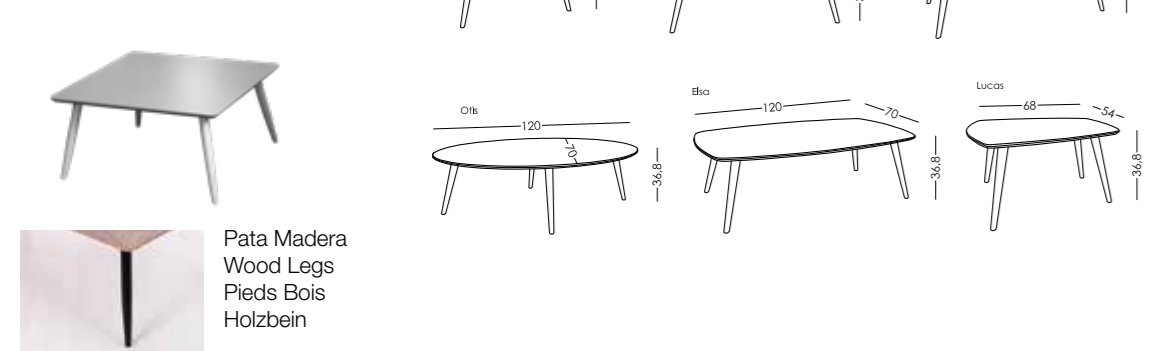

Conec-Table

pag. 14-15

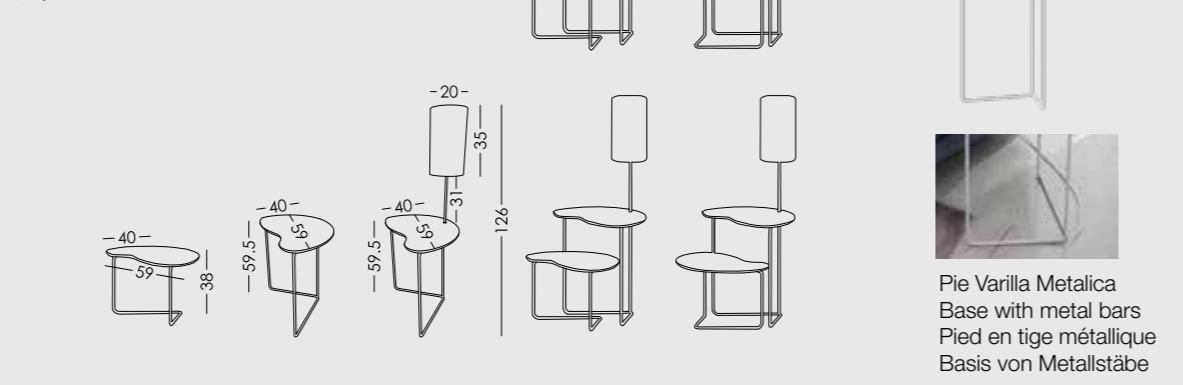

Triovo

pag. 20-21

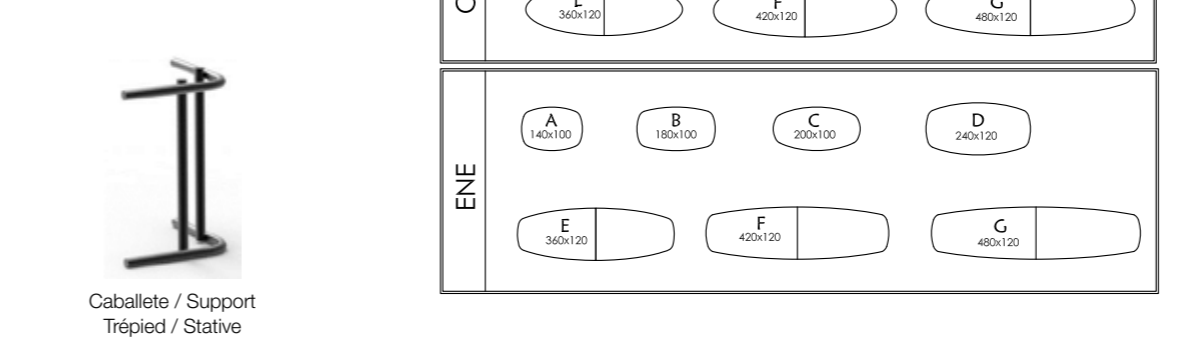

fama



Enjoy the new design
made in Spain

